

クイック継手スマートタイプ

ストレート

●ATS



(1袋10個入り)

チューブサイズ
4
6
8
10
12
16

六角穴付ストレート

●ATSH



(1袋10個入り)

チューブサイズ
4
6
8
10
12

めすストレート

●ATSM



(1袋10個入り)

チューブサイズ
4
6
8
10
12

隔壁ユニオン

●AUK



本体：アルミ（黒アルマイト）
ナット：軟鋼（亜鉛めっき）

(1袋10個入り)

チューブサイズ
4
6
8
10
12

めす隔壁ユニオン

●AUKM



ナット：軟鋼（亜鉛めっき）

(1袋10個入り)

チューブサイズ
4
6
8
10
12

エルボ

●ATL



(1袋10個入り)

チューブサイズ
4
6
8
10
12

ロングエルボ

●ATLL



(1袋10個入り)

チューブサイズ
4
6
8
10
12

ティ

●ATT



(1袋10個入り)

チューブサイズ
4
6
8
10
12

ブランチティ

●ATB



(1袋10個入り)

チューブサイズ
4
6
8
10
12

ブランチワイ

●ATBY



(1袋10個入り)

チューブサイズ
4
6
8
10
12

ブランチエルボワイ

●ATBLY



(1袋10個入り)

チューブサイズ
4
6
8
10
12

ブランチ2重ワイ

●ATBW



(1袋10個入り)

チューブサイズ
4
6

クイック継手スマートタイプ

ブランチトリプル

●ATBE



(1袋10個入り)

チューブサイズ

6-4
8-4
8-6
10-8

ブランチトリプルダブル

●ATBEW



(1袋10個入り)

チューブサイズ

8-4
8-6
10-6
10-8

ブランチテトラ

●ATBZ



(1袋10個入り)

チューブサイズ

4
6
8
10
12

隔壁レギュレーサ

●ASKR



(1袋1個入り)

チューブサイズ

4
6
8
10
12

ストレート

●ATS



(1袋10個入り)

チューブサイズ
4
6
8
10
12
16

注文記号

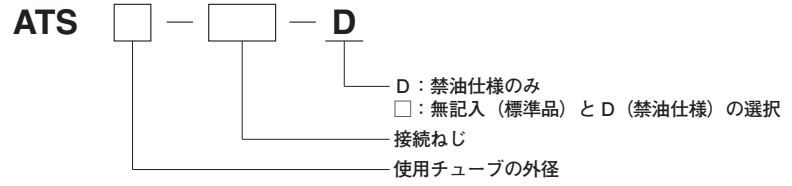

寸法図 (mm)

ストレート
ATS

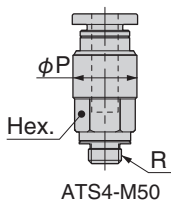
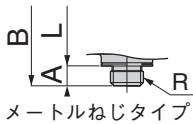
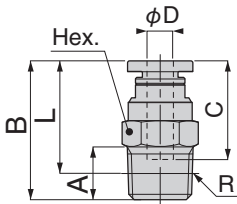

形式	チューブ外径 φD	R	A	B	L	C	対辺 Hex.	φP	オリフィス径 (φmm)	質量 (g)
ATS4-M5-D	4	M5×0.8	2.8	19.8	17	14.9	10	—	2.4	5.6
ATS4-M50-□	4	M5×0.8	2.8	22.7	19.9	14.9	8	9.7	2.4	6.1
ATS4-M6-D	4	M6×1	3.8	20.8	17	14.9	10	—	3	6.0
ATS4-01-D	4	R1/8	8	21	17	14.9	10	—	3	7.4
ATS4-02-□	4	R1/4	11	22.5	16.5	14.9	14	—	3	16
ATS6-M5-D	6	M5×0.8	2.8	21.9	19.1	17	12	—	2.4	8.1
ATS6-M6-D	6	M6×1	3.8	22.9	19.1	17	12	—	3	8.5
ATS6-01-D	6	R1/8	8	22.3	18.3	17	12	—	5	8.2
ATS6-02-□	6	R1/4	11	23.7	17.6	17	14	—	5	15
ATS6-03-□	6	R3/8	12	24.5	18.1	17	17	—	5	28
ATS8-01-□	8	R1/8	8	27.9	23.9	18.2	14	—	6	14
ATS8-02-□	8	R1/4	11	26.6	20.6	18.2	14	—	7	14
ATS8-03-□	8	R3/8	12	25.5	19.2	18.2	17	—	7	25
ATS10-01-□	10	R1/8	8	30.3	26.3	20.7	17	—	6	21
ATS10-02-□	10	R1/4	11	29.8	23.8	20.7	17	—	8.5	19
ATS10-03-□	10	R3/8	12	29.3	23	20.7	17	—	9	24
ATS10-04-□	10	R1/2	15	30.4	22.2	20.7	21	—	9	46
ATS12-02-□	12	R1/4	11	35.9	29.9	23.3	21	—	8.5	37
ATS12-03-□	12	R3/8	12	31.9	25.6	23.3	21	—	11	30
ATS12-04-□	12	R1/2	15	33.9	25.7	23.3	21	—	11	44
ATS16-03-□	16	R3/8	12	39.3	33	24.8	24	—	11	54
ATS16-04-□	16	R1/2	15	41.3	33.1	24.8	24	—	13	63

*-D⇒禁油仕様のみ、-□⇒無記入 (標準品) と D (禁油仕様) の選択

*テーパねじタイプのL寸法は、ねじ締付け後の参考寸法です。

●ATSH



(1袋10個入り)

チューブサイズ
4
6
8
10
12

注文記号

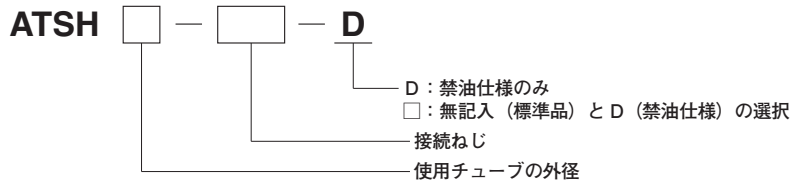

寸法図 (mm)

六角穴付ストレート
ATSH

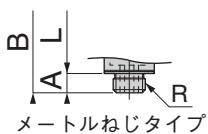
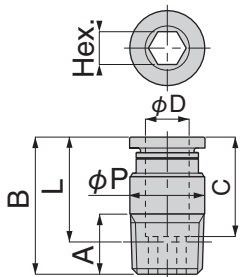

形 式	チューブ外径 φD	R	A	B	L	C	対辺 Hex.	φP	オリフィス径 (φmm)	質量 (g)
ATSH4-M5-D	4	M5×0.8	2.8	19.7	16.9	14.9	2.5	9.7	2.6	4.6
ATSH4-M6-D	4	M6×1	3.8	20.7	16.9	14.9	2.5*	9.7	2.6*	5.4
ATSH4-01-D	4	R1/8	8	20	16	14.9	2.5	9.7	2.6	6.6
ATSH6-M5-D	6	M5×0.8	2.8	21.3	18.5	17	2.5	11.8	2.6	5.6
ATSH6-M6-D	6	M6×1	3.8	22.3	18.5	17	3	11.8	3.2	6.3
ATSH6-01-D	6	R1/8	8	22.1	18.1	17	4	11.8	4.2	7.6
ATSH6-02-□	6	R1/4	11	21.3	15.2	17	4	13.7	4.2	13
ATSH8-01-□	8	R1/8	8	25.9	21.9	18.2	5	13.7	5.3	8.8
ATSH8-02-□	8	R1/4	11	25.1	19.1	18.2	6	13.7	6.3	13
ATSH8-03-□	8	R3/8	12	22.2	15.9	18.2	6	16.8	6.3	19
ATSH10-02-□	10	R1/4	11	29.8	23.8	20.7	6	17.5	6.3	20
ATSH10-03-□	10	R3/8	12	29.3	23	20.7	6	17.5	6.3	26
ATSH10-04-□	10	R1/2	15	30.3	22.1	20.7	6	20.8	6.3	45
ATSH12-03-□	12	R3/8	12	31.9	25.6	23.3	8	20.8	8.4	31
ATSH12-04-□	12	R1/2	15	33.9	25.7	23.3	8	20.8	8.4	45

※六角レンチ干渉によるロック爪不具合を改善するため、内径六角対辺を見直し、オリフィス径が変更になりました。

*-D ⇒ 禁油仕様のみ、-□ ⇒ 無記入 (標準品) と D (禁油仕様) の選択

*テーパねじタイプのL寸法は、ねじ締付け後の参考寸法です。

めすストレート

●ATSM



(1袋10個入り)

チューブサイズ
4
6
8
10
12

注文記号

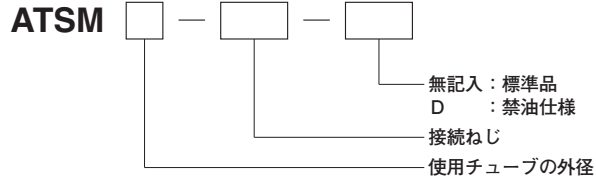

寸法図 (mm)

めすストレート
ATSM

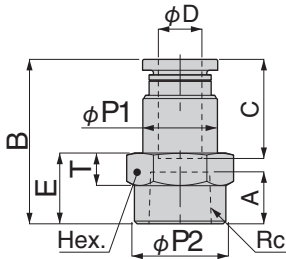

形式	チューブ外径 φD	Rc	A	B	E	φP1	φP2	C	対辺 Hex.	T	オリフィス径 (φmm)	質量 (g)
ATSM4-01-□	4	Rc1/8	7	23.9	10	9.7	13.8	14.9	14	5	3	13
ATSM4-02-□	4	Rc1/4	9.5	26.9	13	9.7	16.8	14.9	17	6	3	19
ATSM6-01-□	6	Rc1/8	7	26	10	11.8	13.8	17	14	5	5	15
ATSM6-02-□	6	Rc1/4	9.5	29	13	11.8	16.8	17	17	6	5	21
ATSM8-01-□	8	Rc1/8	7	27.2	10	13.7	13.8	18.2	14	5	7	16
ATSM8-02-□	8	Rc1/4	9.5	30.2	13	13.7	16.8	18.2	17	6	7	22
ATSM8-03-□	8	Rc3/8	10.5	31.2	14	13.7	20.8	18.2	21	6.5	7	30
ATSM10-02-□	10	Rc1/4	9.5	32.7	13	17.5	16.8	20.7	17	6	9	28
ATSM10-03-□	10	Rc3/8	10.5	33.7	14	17.5	20.8	20.7	21	6.5	9	37
ATSM12-02-□	12	Rc1/4	9.5	34.8	13.5	20.8	16.8	23.3	21	6.5	11	42
ATSM12-03-□	12	Rc3/8	10.5	36.3	14	20.8	20.8	23.3	21	6.5	11	44

* □⇒無記入（標準品）とD（禁油仕様）の選択

●AUK



本体：アルミ（黒アルマイト）
ナット：軟鋼（亜鉛めっき）

（1袋10個入り）

チューブサイズ

4
6
8
10
12

注文記号

AUK

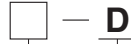

D：禁油仕様のみ

□：無記入（標準品）と D（禁油仕様）の選択

使用チューブの外径

寸法図 (mm)

隔壁ユニオン
AUK



形式	チューブ外径 φD	M	B	E	A	φP	C	対辺 Hex.	T	オリフィス径 (φmm)	質量 (g)
AUK4-D	4	M12×1	30.8	9.5	14.8	10.8	14.9	14	4	3	11
AUK6-D	6	M14×1	34.9	9.5	19	12.5	17	17	4	5	16
AUK8-□	8	M16×1	37.4	10.5	19.4	14.6	18.2	19	4	7	19
AUK10-□	10	M20×1	42.4	11.9	21.6	18.5	20.7	24	5	9	35
AUK12-□	12	M22×1	47.6	13.2	24.2	20.4	23.3	27	6	11	52

*-D ⇒ 禁油仕様のみ、-□ ⇒ 無記入（標準品）と D（禁油仕様）の選択

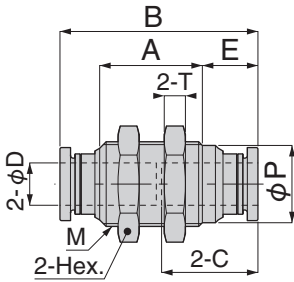

めす隔壁ユニオン

●AUKM



ナット: 軟鋼 (亜鉛めっき)

(1袋10個入り)

チューブサイズ
4
6
8
10
12

注文記号

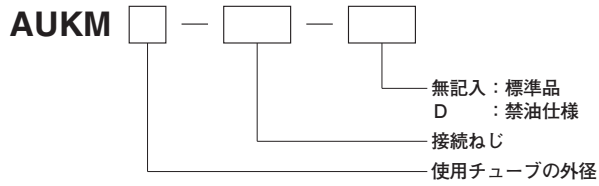

寸法図 (mm)

めす隔壁ユニオン
AUKM

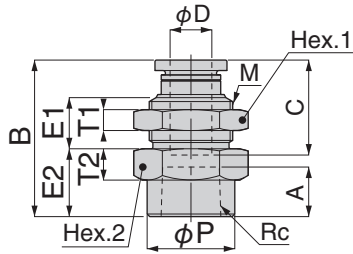

形式	チューブ外径 φD	Rc	M	B	E1	E2	A	C	φP	対辺 Hex.1	対辺 Hex.2	T1	T2	オリフィス径 (φmm)	質量 (g)
AUKM4-01-□	4	Rc1/8	M12×1	24.2	9	9	7	14.9	13.8	14	14	4	5	3	17
AUKM6-01-□	6	Rc1/8	M14×1	26.4	10.2	10	7	17	13.8	17	17	4	6	5	25
AUKM6-02-□	6	Rc1/4	M14×1	28.7	10.2	12.3	9.5	17	16.8	17	17	4	6	5	26
AUKM8-01-□	8	Rc1/8	M16×1	27	9.8	10	7	18.2	13.8	19	19	4	6	7	30
AUKM8-02-□	8	Rc1/4	M16×1	30	9.8	13	9.5	18.2	16.8	19	19	4	6	7	32
AUKM8-03-□	8	Rc3/8	M16×1	31	9.8	14	10.5	18.2	19.5	19	19	4	6	7	30
AUKM10-02-□	10	Rc1/4	M20×1	32.7	11.1	13	9.5	20.7	16.8	24	24	5	7	9	55
AUKM10-03-□	10	Rc3/8	M20×1	33.7	11.1	14	10.5	20.7	20.8	24	24	5	7	9	56
AUKM12-03-□	12	Rc3/8	M22×1	36.3	12.4	14	10.5	23.3	20.8	27	24	6	7	11	65
AUKM12-04-□	12	Rc1/2	M22×1	39.3	12.4	17	13	23.3	25	27	24	6	7	11	67

* □⇒無記入 (標準品) と D (禁油仕様) の選択

●ATL



チューブサイズ
4
6
8
10
12

(1袋10個入り)

注文記号

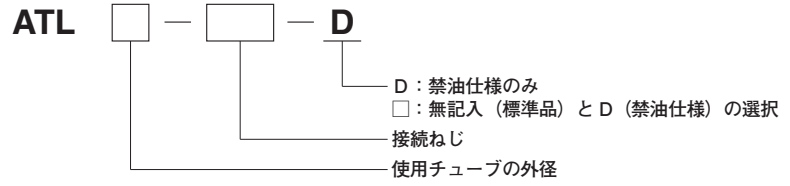

寸法図 (mm)

エルボ
ATL

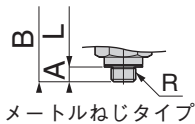
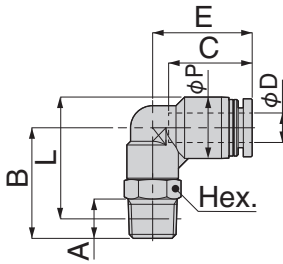

メートルねじタイプ

形式	チューブ外径 φD	R	A	B	L	φP	C	E	対辺 Hex.	ポリフィス径 (φmm)	質量 (g)
ATL4-M5-D	4	M5×0.8	2.8	16	18.2	10	14.9	17.7	8	2.4	5.7
ATL4-M6-D	4	M6×1	3.8	20	21.2	10	14.9	18.7	10	2.4	8.0
ATL4-01-D	4	R1/8	8	22	23	10	14.9	18.7	10	2.8	10
ATL4-02-□	4	R1/4	11	29	28	10	14.9	20.7	14	2.8	18
ATL6-M5-D	6	M5×0.8	2.8	19.5	23	12.5	17	20.3	10	2.4	8.9
ATL6-M6-D	6	M6×1	3.8	20.5	23	12.5	17	20.3	10	3	8.0
ATL6-01-D	6	R1/8	8	22.5	24.8	12.5	17	20.3	10	4.3	11
ATL6-02-□	6	R1/4	11	28	28.2	12.5	17	21.8	14	4.3	19
ATL6-03-□	6	R3/8	12	31.5	31.4	12.5	17	23.8	17	4.3	30
ATL8-01-□	8	R1/8	8	24	27.3	14.5	18.1	22.7	12	6	14
ATL8-02-□	8	R1/4	11	28	29.2	14.5	18.1	23.7	14	6.7	20
ATL8-03-□	8	R3/8	12	31	31.9	14.5	18.1	24.7	17	6.7	31
ATL10-01-□	10	R1/8	8	25	29.8	17.5	20.2	25.5	12	6	18
ATL10-02-□	10	R1/4	11	28.5	31.2	17.5	20.2	26	14	8	23
ATL10-03-□	10	R3/8	12	32	34.4	17.5	20.2	27	17	8.3	34
ATL10-04-□	10	R1/2	15	36	36.6	17.5	20.2	27.5	21	8.3	57
ATL12-02-□	12	R1/4	11	29.8	34.2	21	23.4	29	14	8	27
ATL12-03-□	12	R3/8	12	32.5	36.7	21	23.4	29.7	17	10	38
ATL12-04-□	12	R1/2	15	36.5	38.8	21	23.4	30.7	21	10.3	61

*-D⇒禁油仕様のみ、-□⇒無記入 (標準品) と D (禁油仕様) の選択

*テーパねじタイプのL寸法は、ねじ締付け後の参考寸法です。

●ATLL



(1袋10個入り)

チューブサイズ
4
6
8
10
12

注文記号

ATLL

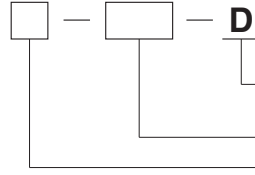

D: 禁油仕様のみ
 □: 無記入 (標準品) と D (禁油仕様) の選択
 接続ねじ
 使用チューブの外径

寸法図 (mm)

ロングエルボ
ATLL

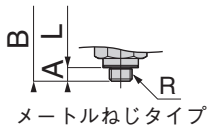
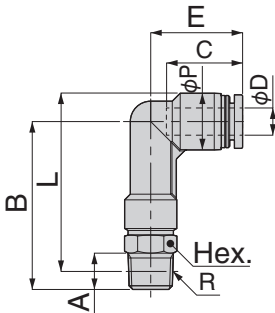

形式	チューブ外径 φD	R	A	B	L	φP	C	E	対辺 Hex.	ホイス径 (φmm)	質量 (g)
ATLL4-M5-D	4	M5×0.8	2.8	28	30.2	10	14.9	18.7	8	2.4	6.4
ATLL4-01-D	4	R1/8	8	34	35	10	14.9	18.7	10	2.8	11
ATLL6-01-D	6	R1/8	8	37	39.3	12.5	17	20.3	10	4.3	13
ATLL6-02-□	6	R1/4	11	42.5	42.7	12.5	17	21.8	14	4.3	20
ATLL6-03-□	6	R3/8	12	46	45.9	12.5	17	23.8	17	4.3	33
ATLL8-01-□	8	R1/8	8	40.5	43.8	14.5	18.1	22.7	12	6	16
ATLL8-02-□	8	R1/4	11	44.5	45.7	14.5	18.1	23.7	14	6.7	22
ATLL8-03-□	8	R3/8	12	47.5	48.4	14.5	18.1	24.7	17	6.7	35
ATLL10-02-□	10	R1/4	11	48	50.7	17.5	20.2	26	14	8	26
ATLL10-03-□	10	R3/8	12	51.5	53.9	17.5	20.2	27	17	8.3	38
ATLL10-04-□	10	R1/2	15	55.5	56.1	17.5	20.2	27	21	8.3	63
ATLL12-02-□	12	R1/4	11	52.8	57.2	21	23.4	29	14	8	30
ATLL12-03-□	12	R3/8	12	55.5	59.7	21	23.4	29.7	17	10	42
ATLL12-04-□	12	R1/2	15	59.5	61.8	21	23.4	29.7	21	10.3	68

*-D ⇒ 禁油仕様のみ、-□ ⇒ 無記入 (標準品) と D (禁油仕様) の選択
 *テーパねじタイプの L 寸法は、ねじ締付け後の参考寸法です。

ティー

●ATT



(1袋10個入り)

チューブサイズ

4
6
8
10
12

注文記号

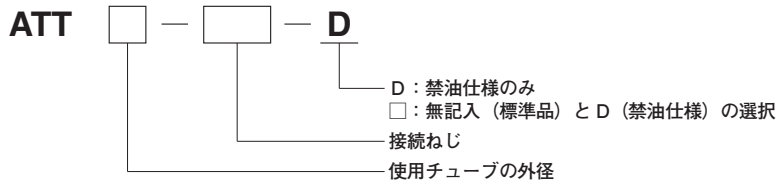

寸法図 (mm)

ティー
ATT

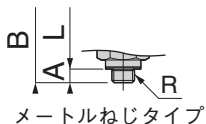
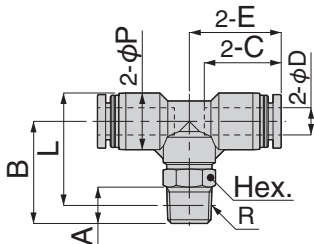

形式	チューブ外径 φD	R	A	B	L	φP	C	E	対辺 Hex.	ポリフィス径 (φmm)	質量 (g)
ATT4-M5-D	4	M5×0.8	2.8	16	18.2	10	14.9	17.7	8	2.4	8
ATT4-M6-D	4	M6×1	3.8	20	21.2	10	14.9	18.7	10	2.4	11
ATT4-01-D	4	R1/8	8	22	23	10	14.9	18.7	10	2.8	13
ATT4-02-□	4	R1/4	11	29	28	10	14.9	20.7	14	2.8	20
ATT6-M5-D	6	M5×0.8	2.8	19.5	23	12.5	17	20.25	10	2.4	12
ATT6-M6-D	6	M6×1	3.8	20.5	23	12.5	17	20.25	10	3	13
ATT6-01-D	6	R1/8	8	22.5	24.8	12.5	17	20.25	10	4.3	14
ATT6-02-□	6	R1/4	11	28	28.2	12.5	17	21.75	14	4.3	22
ATT6-03-□	6	R3/8	12	31.5	31.4	12.5	17	23.75	17	4.3	33
ATT8-01-□	8	R1/8	8	24	27.3	14.5	18.1	22.7	12	6	19
ATT8-02-□	8	R1/4	11	28	29.2	14.5	18.1	23.7	14	6.7	25
ATT8-03-□	8	R3/8	12	31	31.9	14.5	18.1	24.7	17	6.7	35
ATT10-02-□	10	R1/4	11	28.5	31.2	17.5	20.2	26	14	8	31
ATT10-03-□	10	R3/8	12	32	34.4	17.5	20.2	27	17	8.3	42
ATT10-04-□	10	R1/2	15	36	36.6	17.5	20.2	27.5	21	8.3	65
ATT12-02-□	12	R1/4	11	29.8	34.2	21	23.4	28.95	14	8	38
ATT12-03-□	12	R3/8	12	32.5	36.7	21	23.4	29.7	17	10	48
ATT12-04-□	12	R1/2	15	36.5	38.8	21	23.4	30.7	21	10.3	72

*D ⇒ 禁油仕様のみ、-□ ⇒ 無記入 (標準品) と D (禁油仕様) の選択

*テーパねじタイプのL寸法は、ねじ締付け後の参考寸法です。

●ATB



(1袋10個入り)

チューブサイズ
4
6
8
10
12

注文記号

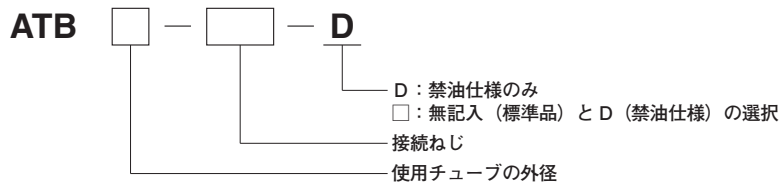

寸法図 (mm)

ブランチティー
ATB

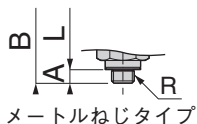
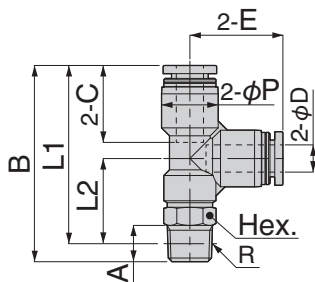

形式	チューブ外径 φD	R	A	B	L1	L2	φP	C	E	対辺 Hex.	オアリス径 (φmm)	質量 (g)
ATB4-M5-D	4	M5×0.8	2.8	33.7	30.9	13.7	10	14.9	17.2	8	2.4	7.8
ATB4-M6-D	4	M6×1	3.8	38.2	34.4	17.2	10	14.9	17.2	10	2.4	11
ATB4-01-D	4	R1/8	8	40.2	36.2	19	10	14.9	17.2	10	2.8	13
ATB4-02-□	4	R1/4	11	46.2	40.2	23	10	14.9	19.2	14	2.8	20
ATB6-M5-D	6	M5×0.8	2.8	40.3	37.5	17	12.5	17	20.5	10	2.4	12
ATB6-M6-D	6	M6×1	3.8	41.3	37.5	17	12.5	17	20.5	10	3	12
ATB6-01-D	6	R1/8	8	43.3	39.3	18.8	12.5	17	20.5	10	4.3	14
ATB6-02-□	6	R1/4	11	48.8	42.7	22.2	12.5	17	20.5	14	4.3	22
ATB6-03-□	6	R3/8	12	52	45.7	25.2	12.5	17	21.5	17	4.3	32
ATB8-01-□	8	R1/8	8	46.9	42.9	20	14.5	18.1	22.9	12	6	19
ATB8-02-□	8	R1/4	11	51.7	45.7	22.8	14.5	18.1	22.9	14	6.7	25
ATB8-03-□	8	R3/8	12	55.4	49.1	26.2	14.5	18.1	22.9	17	6.7	35
ATB10-02-□	10	R1/4	11	54.7	48.7	22.5	17.5	20.2	26.2	14	8	31
ATB10-03-□	10	R3/8	12	58.2	51.9	25.7	17.5	20.2	26.2	17	8.3	42
ATB10-04-□	10	R1/2	15	62.2	54	27.8	17.5	20.2	27.3	21	8.3	65
ATB12-02-□	12	R1/4	11	60.3	54.2	23.7	21	23.4	30	14	8	38
ATB12-03-□	12	R3/8	12	63.5	57.2	26.7	21	23.4	30.5	17	10	48
ATB12-04-□	12	R1/2	15	67.5	59.3	28.8	21	23.4	30.7	21	10.3	72

*-D ⇒ 禁油仕様のみ、-□ ⇒ 無記入 (標準品) と D (禁油仕様) の選択

*テーパねじタイプのL寸法は、ねじ締付け後の参考寸法です。

ブランチワイ

●ATBY



(1袋10個入り)

チューブサイズ

4
6
8
10
12

注文記号

ATBY

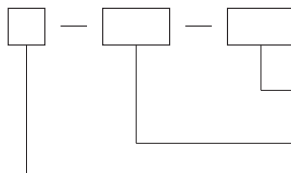

無記入：標準品
D：禁油仕様
接続ねじ
使用チューブの外径

寸法図 (mm)

ブランチワイ
ATBY

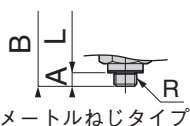
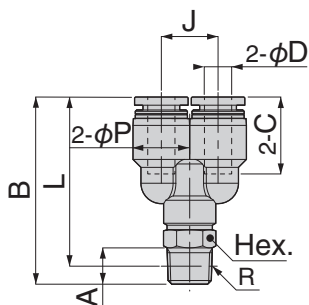

形式	チューブ外径 φD	R	A	B	L	φP	C	J	φd	F	T	対辺 Hex.	ホワ径 (φmm)	質量 (g)
ATBY4-M5-□	4	M5×0.8	2.8	32.9	30.1	10	14.9	10.3	—	—	—	8	2.4	8
ATBY4-01-□	4	R1/8	8	38.4	34.4	10	14.9	10.3	—	—	—	10	2.8	13
ATBY4-02-□	4	R1/4	11	43.4	37.4	10	14.9	10.3	—	—	—	14	2.8	20
ATBY6-M5-□	6	M5×0.8	2.8	38.3	35.5	12.5	17	12.5	—	—	—	10	2.4	13
ATBY6-M6-□	6	M6×1	3.8	39.3	35.5	12.5	17	12.5	—	—	—	10	3	13
ATBY6-01-□	6	R1/8	8	41.3	37.3	12.5	17	12.5	—	—	—	10	4.3	15
ATBY6-02-□	6	R1/4	11	48.3	42.2	12.5	17	12.5	—	—	—	14	4.3	22
ATBY6-03-□	6	R3/8	12	51.3	44.9	12.5	17	12.5	—	—	—	17	4.3	33
ATBY8-01-□	8	R1/8	8	46.1	42.1	14.5	18.1	14.5	—	—	—	12	6	20
ATBY8-02-□	8	R1/4	11	49.3	43.3	14.5	18.1	14.5	—	—	—	14	6.7	25
ATBY8-03-□	8	R3/8	12	52.5	46.2	14.5	18.1	14.5	—	—	—	17	6.7	36
ATBY10-02-□	10	R1/4	11	53.6	47.6	17.5	20.2	17.5	—	—	—	14	8	32
ATBY10-03-□	10	R3/8	12	56.7	50.4	17.5	20.2	17.5	—	—	—	17	8.3	43
ATBY10-04-□	10	R1/2	15	60.2	52	17.5	20.2	17.5	—	—	—	21	8.3	66
ATBY12-02-□	12	R1/4	11	58.6	52.6	21	23.4	21	—	—	—	14	8	40
ATBY12-03-□	12	R3/8	12	60.6	54.3	21	23.4	21	—	—	—	17	10	51
ATBY12-04-□	12	R1/2	15	64.7	56.5	21	23.4	21	—	—	—	21	10.3	74

* □⇒無記入（標準品）とD（禁油仕様）の選択

* テーパねじタイプのL寸法は、ねじ締付け後の参考寸法です。

ブランチエルボワイ

●ATBLY



(1袋10個入り)

チューブサイズ
4
6
8
10
12

注文記号

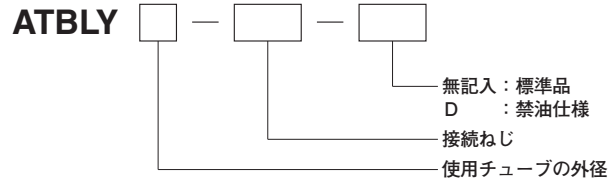

寸法図 (mm)

ブランチエルボワイ
ATBLY

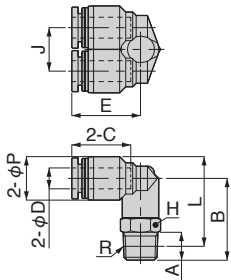

メートルねじタイプ

形式	チューブ外径 φD	R	A	B	L ^注	φP	C	J	E	対辺 H	ねじ径 (φmm)	質量 (g)	
ATBLY4-M5-□	4	M5×0.8	2.8	20	22.2	10	14.9	10.3	18.2	10	2.4	11	
ATBLY4-M6-□		M6×1	3.8	21							3		
ATBLY4-01-□		R1/8	8	23							24		3.9
ATBLY4-02-□		R1/4	11	27							26		
ATBLY6-M5-□	6	M5×0.8	2.8	20.5	24	12.5	17	12.5	19.8	10	2.4	12	
ATBLY6-M6-□		M6×1	3.8	21.5							3		
ATBLY6-01-□		R1/8	8	23.5							25.8		4.2
ATBLY6-02-□		R1/4	11	29							29.2		
ATBLY6-03-□	R3/8	12	31.5	31.4	21.8	14	5.3	22					
ATBLY8-01-□	8	R1/8	8	25	28.3	14.5	18.1	14.5	22.7	12	5.7	20	
ATBLY8-02-□		R1/4	11	29	30.2				23.7	14	7.3	25	
ATBLY8-03-□		R3/8	12	32	32.9				24.7	17		37	
ATBLY10-02-□	10	R1/4	11	29.5	32.2	17.5	20.2	17.5	26	14	8	32	
ATBLY10-03-□		R3/8	12	32.5	34.9				27	17	9.2	43	
ATBLY10-04-□		R1/2	15	37	37.6				28	21		66	
ATBLY12-02-□	12	R1/4	11	29.5	34	21	23.4	21	28.2	14	8	39	
ATBLY12-03-□		R3/8	12	33.5	37.7				29.2	17	9.7	51	
ATBLY12-04-□		R1/2	15	38	40.3				30.2	21		10.6	74

* □⇒無記入（標準品）とD（禁油仕様）の選択

* テーパーねじタイプのL寸法は、ねじ締付け後の参考寸法です。

ブランチ2重ワイ

●ATBW



(1袋10個入り)

チューブサイズ
4
6

注文記号

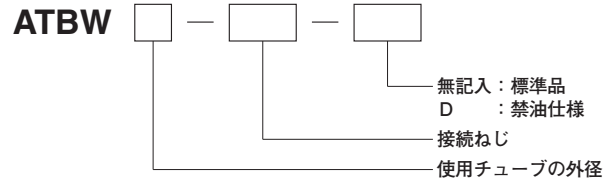

寸法図 (mm)

ブランチ2重ワイ
ATBW



形 式	チューブ外径 φD	R	A	B	L ^注	φP	C	J	対辺 H	ポリス径 (φmm)	質量 (g)
ATBW4-01-□	4	R1/8	8	38.9	34.9	10.5	14.9	10.3	12	2.6	16
ATBW4-02-□		R1/4	11	42.4	36.4				14		
ATBW6-01-□	6	R1/8	8	47.2	43.2	13	17	12.5	12	5.2	25

*-□⇒無記入（標準品）とD（禁油仕様）の選択

*テーパねじタイプのL寸法は、ねじ締付け後の参考寸法です。

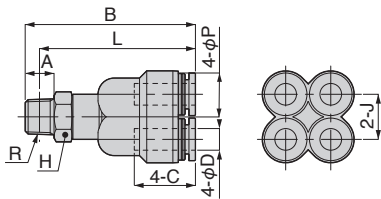

ブランチトリプル

●ATBE



(1袋10個入り)

チューブサイズ

6-4
8-4
8-6
10-8

注文記号

ATBE

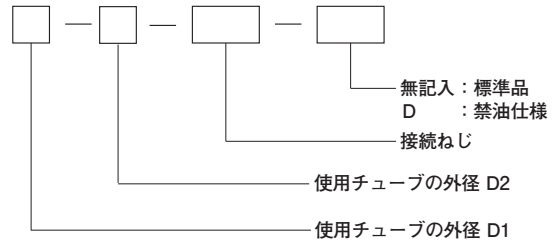

寸法図 (mm)

ブランチトリプル
ATBE

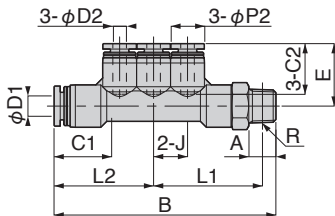
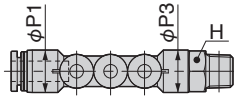

形式	チューブ外径 φD1	チューブ外径 φD2	R	A	B	E	L1 ^注	L2	J	φP1	φP2	φP3
ATBE6-4-01-□	6	4	R1/8	8	65.4	18.4	32.1	29.3	10	12.5	10	12.5
ATBE8-4-02-□	8	4	R1/4	11	69.2	19.2	32	31.2	10	14.5		12.5
ATBE8-6-02-□		6		11	76.9	21.3	36.5	34.4	12.5			
ATBE10-8-03-□	10	8	R3/8	12	87.8	23.7	41.5	40	14.5	17.5	14.5	18

形式	C1	C2	対辺 H	材厚 (φmm)	質量 (g)
ATBE6-4-01-□	17	14.9	12	3	21
ATBE8-4-02-□	18.1	14.9	14	3	28
ATBE8-6-02-□	18.1	17		4.6	35
ATBE10-8-03-□	20.2	18.1	17	6.7	50

*-□⇒無記入（標準品）とD（禁油仕様）の選択

*テーパねじタイプのL寸法は、ねじ締付け後の参考寸法です。

ブランチトリプルダブル

●ATBEW



(1袋10個入り)

チューブサイズ
8-4
8-6
10-6
10-8

注文記号

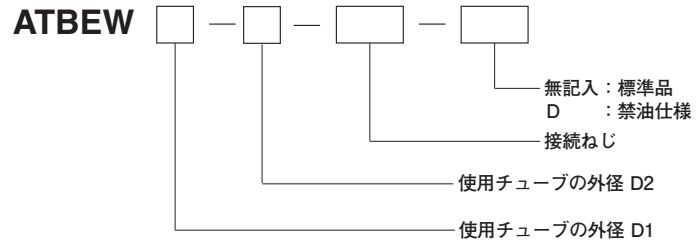

寸法図 (mm)

ブランチトリプルダブル
ATBEW

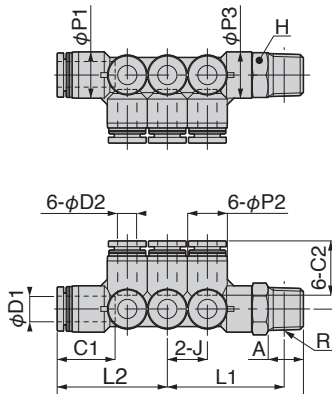

形式	チューブ外径 φD1	チューブ外径 φD2	R	A	B	E	L1 ^注	L2	J	φP1	φP2	φP3				
ATBEW8-4-02-□	8	4	R1/4	11	69.2	19.2	32	31.2	10	14.5	10	14.5				
ATBEW8-4-03-□			R3/8	12	72.2		37.7									
ATBEW8-6-02-□		6	R1/4	11	76.9	21.3	36.5					34.4	12.5	12.5	14.5	
ATBEW8-6-03-□			R3/8	12	80.7		39.9									
ATBEW10-6-03-□	10	6	R3/8	12	81.5	22.3	38.2	37	14.5	17.5	14.5	18				
ATBEW10-6-04-□			R1/2	15	85.5		40.3									
ATBEW10-8-03-□		8	R3/8	12	87.8	23.7	41.5					40	14.5	17.5	14.5	18
ATBEW10-8-04-□			R1/2	15	91.8		43.6									

形式	C1	C2	対辺 H	ボア径 (φmm)	質量 (g)
ATBEW8-4-02-□	18.1	14.9	14	3	32
ATBEW8-4-03-□			17		46
ATBEW8-6-02-□		14	41		
ATBEW8-6-03-□	20.2	17	17	4.6	52
ATBEW10-6-03-□			17		56
ATBEW10-6-04-□		21	78		
ATBEW10-8-03-□	18.1	18.1	17	6.7	65
ATBEW10-8-04-□			21		87

*-□⇒無記入（標準品）とD（禁油仕様）の選択
*テーパねじタイプのL寸法は、ねじ締付け後の参考寸法です。

●ATBZ



(1袋10個入り)

チューブサイズ
4
6
8
10
12

注文記号

ATBZ

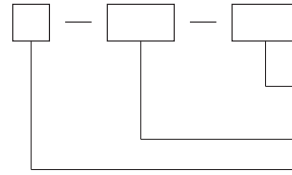

無記入：標準品
D：禁油仕様
接続ねじ
使用チューブの外径

寸法図 (mm)

ブランチテトラ
ATBZ

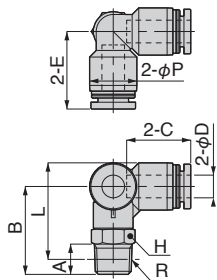

メートルねじタイプ

形式	チューブ外径 φD	R	A	B	L ^注	φP	C	E	対辺 H	オフセット (φmm)	質量 (g)
ATBZ4-M5-□	4	M5×0.8	2.8	20.3	22.5	10	14.9	18.2	10	2.4	10
ATBZ4-M6-□		M6×1	3.8	21.3							
ATBZ4-01-□		R1/8	8	23.3	24.3			3	13		
ATBZ4-02-□		R1/4	11	29						28	20.7
ATBZ6-M5-□	6	M5×0.8	2.8	20.3	23.7	12.5	17	20.5	10	3	12
ATBZ6-M6-□		M6×1	3.8	21.3							
ATBZ6-01-□		R1/8	8	23.3	25.5			4.6	15		
ATBZ6-02-□		R1/4	11	28						28.2	21.8
ATBZ6-03-□	R3/8	12	31.5	31.4	23.8	17	33				
ATBZ8-01-□	8	R1/8	8	25	28.3	14.5	18.1	22.7	12	6	20
ATBZ8-02-□		R1/4	11	29							
ATBZ8-03-□		R3/8	12	32	32.9			24.7	17	6.7	36
ATBZ10-02-□	10	R1/4	11	29.4	32.1	17.5	20.2	26	14	8	31
ATBZ10-03-□		R3/8	12	33							
ATBZ10-04-□		R1/2	15	37	37.6			27.5	21	66	
ATBZ12-02-□	12	R1/4	11	30.8	35.2	21	23.4	30.2	14	8	37
ATBZ12-03-□		R3/8	12	33.5							
ATBZ12-04-□		R1/2	15	38	40.3			31.2	21	10.3	74

* □⇒無記入（標準品）とD（禁油仕様）の選択

* テーパねじタイプのL寸法は、ねじ締付け後の参考寸法です。

●ASKR



メイン側ねじサイズ	サブメイン側チューブサイズ				
	4	6	8	10	12
M8×1 (8)	8-4	8-6	—	—	—
M12×1 (12)	—	12-6	12-8	12-10	—
M14×1 (14)	—	—	14-8	14-10	14-12
M18×1 (18)	—	—	—	—	18-12

注文記号

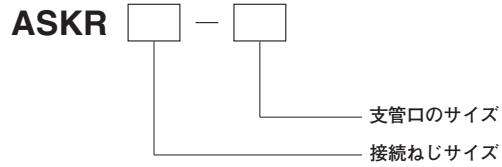

寸法図 (mm)

隔壁レデューサ
ASKR

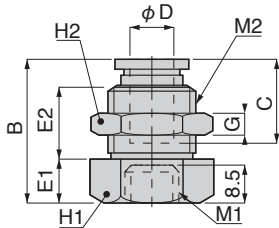

形 式	チューブ外径 φD	M1	M2	B	E1	E2	C	G	対辺 H1	対辺 H2	有効断面積 (mm ²)	質量 (g)	
ASKR8-4	4	M8×1	M12×1	26	8	11.8	14.9	4	14	14	5.6	18	
ASKR8-6	6		M14×1	28.1		13.9	17		17	17	11.5	29	
ASKR12-6	6	M12×1	M14×1	28.1	10	9.9	17	4	17	17	13.2	28	
ASKR12-8	8		M16×1	28.9		11.7	18.2		19	19	27.4	33	
ASKR12-10	10		M20×1	32.3		13.7	20.7		5	22	24	34.8	57
ASKR14-8	8	M14×1	M16×1	28.9	12	9.7	18.2	4	19	19	27.7	32	
ASKR14-10	10		M20×1	32.3		10	13.7		20.7	5	24	41.7	60
ASKR14-12	12		M22×1	34.9		12	13		23.3	6	27	54.7	74
ASKR18-12	12	M18×1	M22×1	34.9	12	13	23.3	6	27	27	66.7	79	